

INSTRUCTION MANUAL

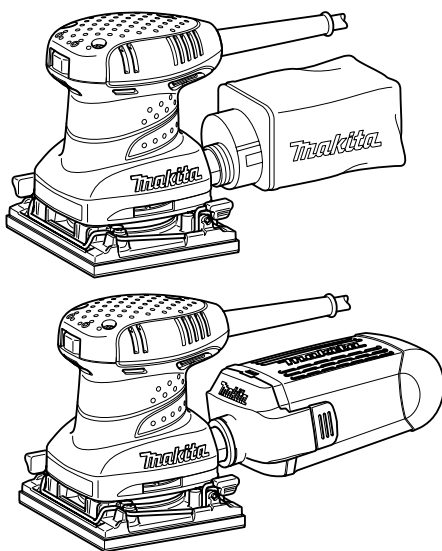

# Finishing Sander

BO4555  
BO4556  
BO4557  
BO4558



009089

 DOUBLE INSULATION

**IMPORTANT:** Read Before Using.

## ENGLISH (Original instructions)

# SPECIFICATIONS

Model	BO4555	BO4556	BO4558	BO4557
Pad size	112mm × 102mm			
Orbits per minute (min <sup>-1</sup> )	14,000			
Dimensions (L x W x H)	131 mm x 112 mm x 142 mm	131 mm x 112 mm x 141 mm		131 mm x 112 mm x 137 mm
Net weight	1.1 kg		1.2 kg	1.0 kg
Safety class	II			

- Due to our continuing programme of research and development, the specifications herein are subject to change without notice.
- Specifications may differ from country to country.
- Weight according to EPTA-Procedure 01/2003

END201-5

The noise level under working may exceed 80 dB (A).

## Symbols

The following show the symbols used for the equipment. Be sure that you understand their meaning before use.



- Read instruction manual.



- DOUBLE INSULATION



- Only for EU countries  
Do not dispose of electric equipment together with household waste material! In observance of European Directive 2002/96/EC on waste electric and electronic equipment and its implementation in accordance with national law, electric equipment that have reached the end of their life must be collected separately and returned to an environmentally compatible recycling facility.

ENE052-1

## Intended use

The tool is intended for the sanding of large surface of wood, plastic and metal materials as well as painted surfaces.

## Power supply

The tool should be connected only to a power supply of the same voltage as indicated on the nameplate, and can only be operated on single-phase AC supply. They are double-insulated in accordance with European Standard and can, therefore, also be used from sockets without earth wire.

ENF002-1

ENG905-1

## Noise

The typical A-weighted noise level determined according to EN60745:

### Model BO4555

Sound pressure level ( $L_{pA}$ ) : 80 dB(A)  
Uncertainty (K) : 3 dB(A)

### Model BO4556

Sound pressure level ( $L_{pA}$ ) : 82 dB(A)  
Sound power level ( $L_{WA}$ ) : 93 dB(A)  
Uncertainty (K) : 3 dB(A)

### Model BO4557

Sound pressure level ( $L_{pA}$ ) : 76 dB(A)  
Uncertainty (K) : 3 dB(A)

The noise level under working may exceed 80 dB (A).

### Model BO4558

Sound pressure level ( $L_{pA}$ ) : 79 dB(A)  
Uncertainty (K) : 3 dB(A)

The noise level under working may exceed 80 dB (A).

## Wear ear protection

ENG900-1

## Vibration

The vibration total value (tri-axial vector sum) determined according to EN60745:

### Model BO4555

Work mode : sanding metal plate  
Vibration emission ( $a_h$ ) : 2.5 m/s<sup>2</sup> or less  
Uncertainty (K) : 1.5 m/s<sup>2</sup>

### Model BO4556

Work mode : sanding metal plate  
Vibration emission ( $a_h$ ) : 3.0 m/s<sup>2</sup>  
Uncertainty (K) : 1.5 m/s<sup>2</sup>

### Model BO4557,BO4558

Work mode : sanding metal plate  
Vibration emission ( $a_h$ ) : 3.5 m/s<sup>2</sup>  
Uncertainty (K) : 1.5 m/s<sup>2</sup>

- The declared vibration emission value has been measured in accordance with the standard test method and may be used for comparing one tool with another.
- The declared vibration emission value may also be used in a preliminary assessment of exposure.

**⚠ WARNING:**

- The vibration emission during actual use of the power tool can differ from the declared emission value depending on the ways in which the tool is used.
- Be sure to identify safety measures to protect the operator that are based on an estimation of exposure in the actual conditions of use (taking account of all parts of the operating cycle such as the times when the tool is switched off and when it is running idle in addition to the trigger time).

ENH101-14

**For European countries only**

**EC Declaration of Conformity**

**We Makita Corporation as the responsible manufacturer declare that the following Makita machine(s):**

Designation of Machine:

Finishing Sander

Model No./ Type: BO4555,BO4556,BO4557,BO4558

are of series production and

**Conforms to the following European Directives:**  
2006/42/EC

And are manufactured in accordance with the following standards or standardised documents:

EN60745

The technical documentation is kept by our authorised representative in Europe who is:

Makita International Europe Ltd.

Michigan Drive, Tongwell,

Milton Keynes, MK15 8JD, England

8.4.2009



Tomoyasu Kato

Director

Makita Corporation

3-11-8, Sumiyoshi-cho,

Anjo, Aichi, JAPAN

000230

## General Power Tool Safety Warnings

**⚠ WARNING** Read all safety warnings and all instructions. Failure to follow the warnings and instructions may result in electric shock, fire and/or serious injury.

### Save all warnings and instructions for future reference.

The term "power tool" in the warnings refers to your mains-operated (corded) power tool or battery-operated (cordless) power tool.

#### Work area safety

1. **Keep work area clean and well lit.** Cluttered or dark areas invite accidents.
2. **Do not operate power tools in explosive atmospheres, such as in the presence of flammable liquids, gases or dust.** Power tools create sparks which may ignite the dust or fumes.
3. **Keep children and bystanders away while operating a power tool.** Distractions can cause you to lose control.

#### Electrical safety

4. **Power tool plugs must match the outlet. Never modify the plug in any way. Do not use any adapter plugs with earthed (grounded) power tools.** Unmodified plugs and matching outlets will reduce risk of electric shock.
5. **Avoid body contact with earthed or grounded surfaces such as pipes, radiators, ranges and refrigerators.** There is an increased risk of electric shock if your body is earthed or grounded.
6. **Do not expose power tools to rain or wet conditions.** Water entering a power tool will increase the risk of electric shock.
7. **Do not abuse the cord. Never use the cord for carrying, pulling or unplugging the power tool. Keep cord away from heat, oil, sharp edges or moving parts.** Damaged or entangled cords increase the risk of electric shock.
8. **When operating a power tool outdoors, use an extension cord suitable for outdoor use.** Use of a cord suitable for outdoor use reduces the risk of electric shock.
9. **If operating a power tool in a damp location is unavoidable, use a residual current device (RCD) protected supply.** Use of an RCD reduces the risk of electric shock.
10. **Use of power supply via a RCD with a rated residual current of 30mA or less is always recommended.**

## Personal safety

11. **Stay alert, watch what you are doing and use common sense when operating a power tool. Do not use a power tool while you are tired or under the influence of drugs, alcohol or medication.** A moment of inattention while operating power tools may result in serious personal injury.
12. **Use personal protective equipment. Always wear eye protection.** Protective equipment such as dust mask, non-skid safety shoes, hard hat, or hearing protection used for appropriate conditions will reduce personal injuries.
13. **Prevent unintentional starting. Ensure the switch is in the off-position before connecting to power source and/or battery pack, picking up or carrying the tool.** Carrying power tools with your finger on the switch or energising power tools that have the switch on invites accidents.
14. **Remove any adjusting key or wrench before turning the power tool on.** A wrench or a key left attached to a rotating part of the power tool may result in personal injury.
15. **Do not overreach. Keep proper footing and balance at all times.** This enables better control of the power tool in unexpected situations.
16. **Dress properly. Do not wear loose clothing or jewellery. Keep your hair, clothing, and gloves away from moving parts.** Loose clothes, jewellery or long hair can be caught in moving parts.
17. **If devices are provided for the connection of dust extraction and collection facilities, ensure these are connected and properly used.** Use of dust collection can reduce dust-related hazards.

## Power tool use and care

18. **Do not force the power tool. Use the correct power tool for your application.** The correct power tool will do the job better and safer at the rate for which it was designed.
  19. **Do not use the power tool if the switch does not turn it on and off.** Any power tool that cannot be controlled with the switch is dangerous and must be repaired.
  20. **Disconnect the plug from the power source and/or the battery pack from the power tool before making any adjustments, changing accessories, or storing power tools.** Such preventive safety measures reduce the risk of starting the power tool accidentally.
  21. **Store idle power tools out of the reach of children and do not allow persons unfamiliar with the power tool or these instructions to operate the power tool.** Power tools are dangerous in the hands of untrained users.
22. **Maintain power tools. Check for misalignment or binding of moving parts, breakage of parts and any other condition that may affect the power tool's operation. If damaged, have the power tool repaired before use.** Many accidents are caused by poorly maintained power tools.
  23. **Keep cutting tools sharp and clean.** Properly maintained cutting tools with sharp cutting edges are less likely to bind and are easier to control.
  24. **Use the power tool, accessories and tool bits etc. in accordance with these instructions, taking into account the working conditions and the work to be performed.** Use of the power tool for operations different from those intended could result in a hazardous situation.

## Service

25. **Have your power tool serviced by a qualified repair person using only identical replacement parts.** This will ensure that the safety of the power tool is maintained.
26. **Follow instruction for lubricating and changing accessories.**
27. **Keep handles dry, clean and free from oil and grease.**

GE8021-4

## SANDER SAFETY WARNINGS

1. **Always use safety glasses or goggles.** Ordinary eye or sun glasses are NOT safety glasses.
2. **Hold the tool firmly.**
3. **Do not leave the tool running. Operate the tool only when hand-held.**
4. **This tool has not been waterproofed, so do not use water on the workpiece surface.**
5. **Ventilate your work area adequately when you perform sanding operations.**
6. **Some material contains chemicals which may be toxic. Take caution to prevent dust inhalation and skin contact. Follow material supplier safety data.**
7. **Use of this tool to sand some products, paints and wood could expose user to dust containing hazardous substances. Use appropriate respiratory protection.**
8. **Be sure that there are no cracks or breakage on the pad before use. Cracks or breakage may cause a personal injury.**

## SAVE THESE INSTRUCTIONS.

### **WARNING:**

**DO NOT** let comfort or familiarity with product (gained from repeated use) replace strict adherence

to safety rules for the subject product. MISUSE or failure to follow the safety rules stated in this instruction manual may cause serious personal injury.

## FUNCTIONAL DESCRIPTION

### ⚠CAUTION:

- Always be sure that the tool is switched off and unplugged before adjusting or checking function on the tool.

### Switch action

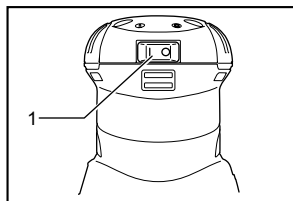

1. Switch

008302

### ⚠CAUTION:

- Before plugging in the tool, always check to see that the tool is switched off.

To start the tool, press the "I" side of the switch. To stop the tool, press the "O" side of the switch.

## ASSEMBLY

### ⚠CAUTION:

- Always be sure that the tool is switched off and unplugged before carrying out any work on the tool.

### Installing or removing abrasive paper

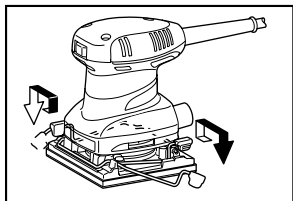

008299

Open the paper clamp by raising on the lever to release from the locking port and then insert the paper end into the clamping part, aligning the paper edges even and parallel with the sides of the base. (Bending the paper beforehand makes attachment easier). Once the paper is in place, return the lever to its original position.

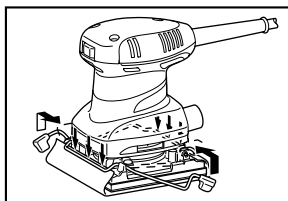

008293

Repeat the same process for the other end of the base, maintaining the proper paper tension.

After inserting the paper, make sure the clamping part hold it securely. Otherwise the paper will be loose and subject to slippage, resulting in uneven sanding operation.

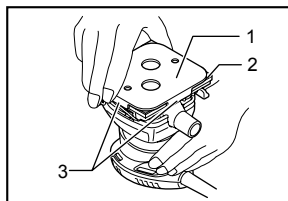

1. Punch plate  
2. Sandpaper  
3. Guide

008297

When using the dust bag, make holes in the abrasive paper using the punch plate as follows:

- Set the tool upside down.
- Place the punch plate over the abrasive paper so that the bent sides of the punch plate are flush with the paper edges.
- Press the punch plate to make holes in the abrasive paper.

### ⚠CAUTION:

- Be sure to remove the punch plate before operating the tool.

### Model BO4555 only

### NOTE:

Use Makita hook-and-loop sandpaper with this sander.

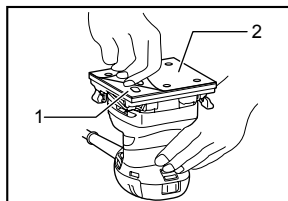

1. Velcro sandpaper  
2. Base

008296

- Set the tool upside down so that the pad is on top.
- Position the sandpaper to fit the shape of the base. Be sure to align the holes on the sandpaper with

the holes on the pad (the dust will be sucked into these holes; it is therefore important to leave them open).

3. Press the paper firmly over the pad.

**To remove the sandpaper:**

1. Set the tool upside down so that the sandpaper is on top.
2. Grasping one corner of the sandpaper, peel it from the pad.

**NOTE:**

- If the sandpaper is in good condition, save it for further use.

**Dust bag (accessory)**

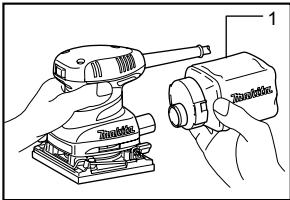

1. Dust bag

008301

The use of the dust bag makes sanding operations clean and dust collection easy. To attach the dust bag, fit the bag's entry port onto the dust spout on the tool. Make sure that the hole in the bag's entry port is just over the pimple-like protrusion on the dust spout.

For the best results, empty the dust bag when it becomes approximately half full, tapping it lightly to remove as much dust as possible.

**Installing paper dust bag (accessory)**

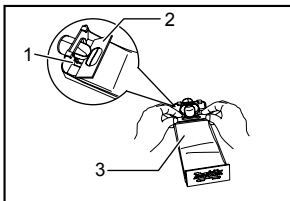

1. Groove
2. Front fixing cardboard
3. Front side of paper dust bag

003742

Place the paper dust bag on the paper dust bag holder with its front side upward. Insert the front fixing cardboard of the paper dust bag into the groove of the paper dust bag holder.

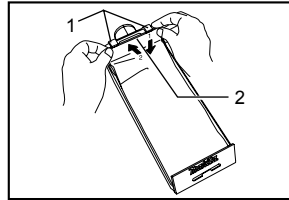

1. Claws
2. Upper part

003743

Then press the upper part of the front fixing cardboard in arrow direction to hook it onto the claws.

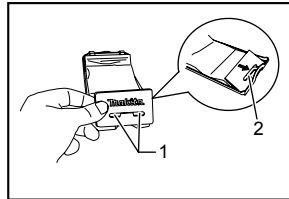

1. Notch
2. Guide

003744

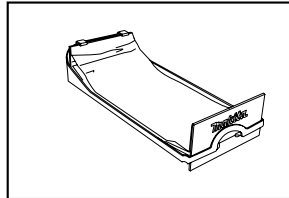

003745

Insert the notch of the paper dust bag into the guide of the paper dust bag holder. Then install the paper dust bag holder set on the tool.

**Installing paper filter bag**

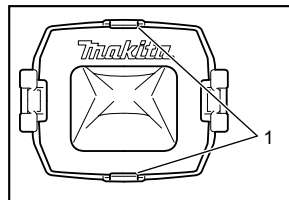

1. Holding tab

009094

Make sure that the logo on the cardboard lip and the logo on the dust box are on the same side, then install the paper filter bag by fitting the cardboard lip in the groove of each holding tab.

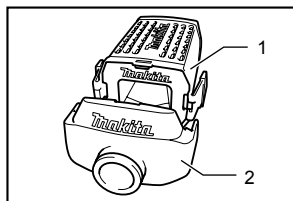

1. Dust box
2. Dust nozzle

009095

Make sure that the logo on the cardboard lip and the logo on the dust nozzle are on the same side, then install the dust nozzle on the dust box.

Removing dust box and paper filter bag.

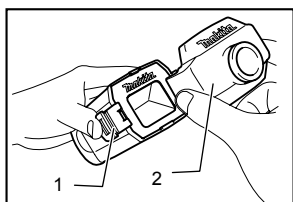

1. Latch
2. Dust nozzle

009092

Remove the dust nozzle by pushing the two latches.

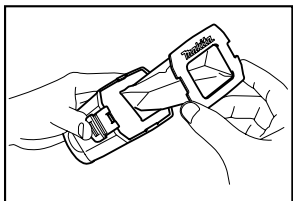

009093

Remove the paper filter bag first by pinching the logo side of its cardboard lip, then by pulling the cardboard lip downwards to move it out of the holding tab of the dust box.

## OPERATION

### Sanding operation

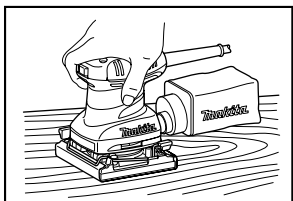

008294

#### ⚠CAUTION:

- Never run the tool without the abrasive paper. You may seriously damage the pad.

- Never force the tool. Excessive pressure may decrease the sanding efficiency, damage the abrasive paper and/or shorten tool life.

Hold the tool firmly. Turn the tool on and wait until it attains full speed. Then gently place the tool on the workpiece surface. A finishing sander is generally used to remove only a small amount of material at a time. Since the quality of the surface is more important than the amount of stock removed, do not bear down on the tool. Keep the base flush with the workpiece at all times.

## MAINTENANCE

#### ⚠CAUTION:

- Always be sure that the tool is switched off and unplugged before attempting to perform inspection or maintenance.
- Never use gasoline, benzine, thinner, alcohol or the like. Discoloration, deformation or cracks may result.

To maintain product SAFETY and RELIABILITY, repairs, carbon brush inspection and replacement, any other maintenance or adjustment should be performed by Makita Authorized Service Centers, always using Makita replacement parts.

## ACCESSORIES

#### ⚠CAUTION:

- These accessories or attachments are recommended for use with your Makita tool specified in this manual. The use of any other accessories or attachments might present a risk of injury to persons. Only use accessory or attachment for its stated purpose.

If you need any assistance for more details regarding these accessories, ask your local Makita Service Center.

- Abrasive paper (without pre-punched holes)
- Paper dust bag
- Paper dust bag holder
- Punch plate
- Dust bag
- Dust box
- Paper filter bag

**Makita Corporation**  
Anjo, Aichi, Japan

884717G227

[www.makita.com](http://www.makita.com)