

INSTRUCTION MANUAL

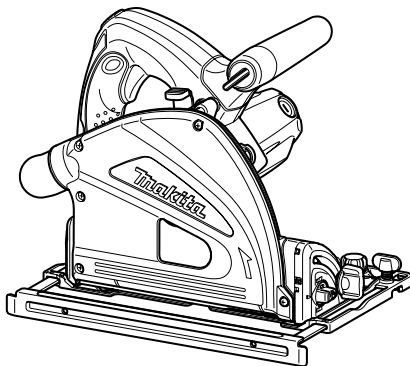

# Plunge Cut Circular Saw

SP6000



007654

 DOUBLE INSULATION

**IMPORTANT:** Read Before Using.

## ENGLISH (Original instructions)

# SPECIFICATIONS

Model		SP6000
Blade diameter		165 mm
Max. cutting depth	at 90°	56 mm
	at 45°	40 mm
	at 48°	38 mm
No load speed (min <sup>-1</sup> )		2,000 - 5,800
Overall length		341 mm
Net weight		4.4 kg
Safety class		II/II

- Due to our continuing program of research and development, the specifications herein are subject to change without notice.
- Specifications may differ from country to country.
- Weight according to EPTA-Procedure 01/2003

END201-6

ENG905-1

## Symbols

The following show the symbols used for the equipment. Be sure that you understand their meaning before use.



- Read instruction manual.



- DOUBLE INSULATION



- Only for EU countries

Do not dispose of electric equipment together with household waste material! In observance of European Directive 2012/19/EU on waste electric and electronic equipment and its implementation in accordance with national law, electric equipment that have reached the end of their life must be collected separately and returned to an environmentally compatible recycling facility.

ENE067-1

## Intended use

The tool is specially intended for performing plunge cuts. In addition, lengthways and crossways straight cuts and mitre cuts with angles in wood can also be performed while in firm contact with the workpiece.

If the tool is equipped with the special saw blade for aluminium, the tool can be used for sawing aluminium.

ENF062-2

## Power supply

The tool should be connected only to a power supply of the same voltage as indicated on the nameplate, and can only be operated on single-phase AC supply. They are double-insulated and can, therefore, also be used from sockets without earth wire.

## Noise

The typical A-weighted noise level determined according to EN60745:

Sound pressure level ( $L_{pA}$ ): 81 dB (A)

Sound power level ( $L_{WA}$ ): 92 dB (A)

Uncertainty (K): 3 dB (A)

## Wear ear protection

ENG900-1

## Vibration

The vibration total value (tri-axial vector sum) determined according to EN60745:

Work mode : cutting wood

Vibration emission ( $a_{h,W}$ ): 2.5 m/s<sup>2</sup> or less

Uncertainty (K): 1.5 m/s<sup>2</sup>

Work mode : cutting metal

Vibration emission ( $a_{h,M}$ ): 2.5 m/s<sup>2</sup> or less

Uncertainty (K): 1.5 m/s<sup>2</sup>

ENG901-1

- The declared vibration emission value has been measured in accordance with the standard test method and may be used for comparing one tool with another.
- The declared vibration emission value may also be used in a preliminary assessment of exposure.

## WARNING:

- The vibration emission during actual use of the power tool can differ from the declared emission value depending on the ways in which the tool is used.
- Be sure to identify safety measures to protect the operator that are based on an estimation of exposure in the actual conditions of use (taking account of all parts of the operating cycle such as

the times when the tool is switched off and when it is running idle in addition to the trigger time).

ENH101-17

### For European countries only

### EC Declaration of Conformity

**Makita declares that the following Machine(s):**

Designation of Machine:

Plunge Cut Circular Saw

Model No./ Type: SP6000

**Conforms to the following European Directives:**

2006/42/EC

They are manufactured in accordance with the following standard or standardized documents:

EN60745

The technical file in accordance with 2006/42/EC is available from:

Makita, Jan-Baptist Vinkstraat 2, 3070, Belgium

31.12.2013



000331

Yasushi Fukaya

Director

Makita, Jan-Baptist Vinkstraat 2, 3070, Belgium

GEA005-3

## General Power Tool Safety Warnings

**⚠ WARNING** Read all safety warnings and all instructions. Failure to follow the warnings and instructions may result in electric shock, fire and/or serious injury.

## Save all warnings and instructions for future reference.

The term "power tool" in the warnings refers to your mains-operated (corded) power tool or battery-operated (cordless) power tool.

### Work area safety

1. **Keep work area clean and well lit.** Cluttered or dark areas invite accidents.
2. **Do not operate power tools in explosive atmospheres, such as in the presence of flammable liquids, gases or dust.** Power tools create sparks which may ignite the dust or fumes.
3. **Keep children and bystanders away while operating a power tool.** Distractions can cause you to lose control.

### Electrical safety

4. **Power tool plugs must match the outlet. Never modify the plug in any way. Do not use any adapter plugs with earthed (grounded) power tools.** Unmodified plugs and matching outlets will reduce risk of electric shock.
5. **Avoid body contact with earthed or grounded surfaces such as pipes, radiators, ranges and refrigerators.** There is an increased risk of electric shock if your body is earthed or grounded.
6. **Do not expose power tools to rain or wet conditions.** Water entering a power tool will increase the risk of electric shock.
7. **Do not abuse the cord. Never use the cord for carrying, pulling or unplugging the power tool. Keep cord away from heat, oil, sharp edges or moving parts.** Damaged or entangled cords increase the risk of electric shock.
8. **When operating a power tool outdoors, use an extension cord suitable for outdoor use.** Use of a cord suitable for outdoor use reduces the risk of electric shock.
9. **If operating a power tool in a damp location is unavoidable, use a residual current device (RCD) protected supply.** Use of an RCD reduces the risk of electric shock.
10. **Use of power supply via a RCD with a rated residual current of 30mA or less is always recommended.**

### Personal safety

11. **Stay alert, watch what you are doing and use common sense when operating a power tool. Do not use a power tool while you are tired or under the influence of drugs, alcohol or medication.** A moment of inattention while operating power tools may result in serious personal injury.
12. **Use personal protective equipment. Always wear eye protection.** Protective equipment such as dust mask, non-skid safety shoes, hard hat, or hearing protection used for appropriate conditions will reduce personal injuries.
13. **Prevent unintentional starting. Ensure the switch is in the off-position before connecting to power source and/or battery pack, picking up or carrying the tool.** Carrying power tools with your finger on the switch or energising power tools that have the switch on invites accidents.
14. **Remove any adjusting key or wrench before turning the power tool on.** A wrench or a key left attached to a rotating part of the power tool may result in personal injury.
15. **Do not overreach. Keep proper footing and balance at all times.** This enables better control of the power tool in unexpected situations.

16. **Dress properly. Do not wear loose clothing or jewellery. Keep your hair, clothing, and gloves away from moving parts.** Loose clothes, jewellery or long hair can be caught in moving parts.
17. **If devices are provided for the connection of dust extraction and collection facilities, ensure these are connected and properly used.** Use of dust collection can reduce dust-related hazards.

#### Power tool use and care

18. **Do not force the power tool. Use the correct power tool for your application.** The correct power tool will do the job better and safer at the rate for which it was designed.
19. **Do not use the power tool if the switch does not turn it on and off.** Any power tool that cannot be controlled with the switch is dangerous and must be repaired.
20. **Disconnect the plug from the power source and/or the battery pack from the power tool before making any adjustments, changing accessories, or storing power tools.** Such preventive safety measures reduce the risk of starting the power tool accidentally.
21. **Store idle power tools out of the reach of children and do not allow persons unfamiliar with the power tool or these instructions to operate the power tool.** Power tools are dangerous in the hands of untrained users.
22. **Maintain power tools. Check for misalignment or binding of moving parts, breakage of parts and any other condition that may affect the power tool's operation. If damaged, have the power tool repaired before use.** Many accidents are caused by poorly maintained power tools.
23. **Keep cutting tools sharp and clean.** Properly maintained cutting tools with sharp cutting edges are less likely to bind and are easier to control.
24. **Use the power tool, accessories and tool bits etc. in accordance with these instructions, taking into account the working conditions and the work to be performed.** Use of the power tool for operations different from those intended could result in a hazardous situation.

#### Service

25. **Have your power tool serviced by a qualified repair person using only identical replacement parts.** This will ensure that the safety of the power tool is maintained.
26. **Follow instruction for lubricating and changing accessories.**
27. **Keep handles dry, clean and free from oil and grease.**

## CIRCULAR SAW SAFETY WARNINGS

### Cutting procedures

1. **⚠ DANGER: Keep hands away from cutting area and the blade. Keep your second hand on auxiliary handle, or motor housing.** If both hands are holding the saw, they cannot be cut by the blade.
2. **Do not reach underneath the workpiece.** The guard cannot protect you from the blade below the workpiece.
3. **Adjust the cutting depth to the thickness of the workpiece.** Less than a full tooth of the blade teeth should be visible below the workpiece.
4. **Never hold piece being cut in your hands or across your leg. Secure the workpiece to a stable platform.** It is important to support the work properly to minimize body exposure, blade binding, or loss of control.

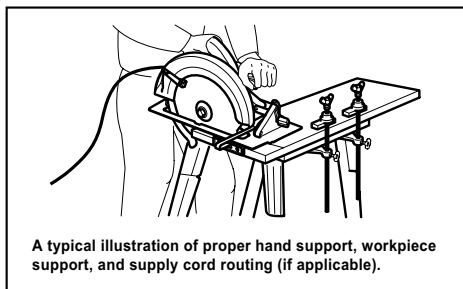

000157

5. **Hold the power tool by insulated gripping surfaces only, when performing an operation where the cutting tool may contact hidden wiring or its own cord.** Contact with a "live" wire will also make exposed metal parts of the power tool "live" and could give the operator an electric shock.
6. **When ripping, always use a rip fence or straight edge guide.** This improves the accuracy of cut and reduces the chance of blade binding.
7. **Always use blades with correct size and shape (diamond versus round) of arbour holes.** Blades that do not match the mounting hardware of the saw will run eccentrically, causing loss of control.
8. **Never use damaged or incorrect blade washers or bolt.** The blade washers and bolt were specially designed for your saw, for optimum performance and safety of operation.

### Kickback causes and related warnings

- kickback is a sudden reaction to a pinched, bound or misaligned saw blade, causing an uncontrolled saw to lift up and out of the workpiece toward the operator;
- when the blade is pinched or bound tightly by the kerf closing down, the blade stalls and the motor reaction drives the unit rapidly back toward the operator;
- if the blade becomes twisted or misaligned in the cut, the teeth at the back edge of the blade can dig into the top surface of the wood causing the blade to climb out of the kerf and jump back toward the operator.

Kickback is the result of saw misuse and/or incorrect operating procedures or conditions and can be avoided by taking proper precautions as given below.

9. **Maintain a firm grip with both hands on the saw and position your arms to resist kickback forces. Position your body to either side of the blade, but not in line with the blade.** Kickback could cause the saw to jump backwards, but kickback forces can be controlled by the operator, if proper precautions are taken.
10. **When blade is binding, or when interrupting a cut for any reason, release the trigger and hold the saw motionless in the material until the blade comes to a complete stop. Never attempt to remove the saw from the work or pull the saw backward while the blade is in motion or kickback may occur.** Investigate and take corrective actions to eliminate the cause of blade binding.
11. **When restarting a saw in the workpiece, centre the saw blade in the kerf and check that saw teeth are not engaged into the material.** If saw blade is binding, it may walk up or kickback from the workpiece as the saw is restarted.
12. **Support large panels to minimise the risk of blade pinching and kickback.** Large panels tend to sag under their own weight. Supports must be placed under the panel on both sides, near the line of cut and near the edge of the panel.

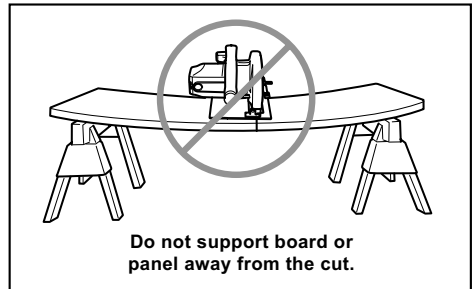
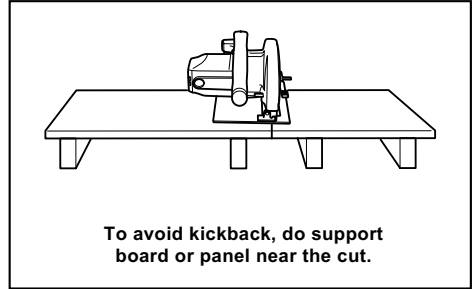

13. **Do not use dull or damaged blades.** Unsharpened or improperly set blades produce narrow kerf causing excessive friction, blade binding and kickback.
14. **Blade depth and bevel adjusting locking levers must be tight and secure before making cut.** If blade adjustment shifts while cutting, it may cause binding and kickback.
15. **Use extra caution when sawing into existing walls or other blind areas.** The protruding blade may cut objects that can cause kickback.
16. **ALWAYS hold the tool firmly with both hands. NEVER place your hand, leg or any part of your body under the tool base or behind the saw, especially when making cross-cuts.** If kickback occurs, the saw could easily jump backwards over your hand, leading to serious personal injury.

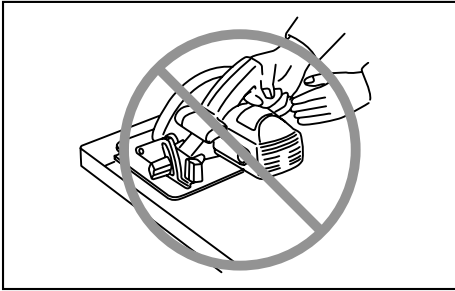

000194

17. **Never force the saw. Push the saw forward at a speed so that the blade cuts without slowing.** Forcing the saw can cause uneven cuts, loss of accuracy, and possible kickback.

**Guard function**

18. **Check guard for proper closing before each use. Do not operate the saw if guard does not move freely and enclose the blade instantly. Never clamp or tie the guard so that the blade is exposed.** If saw is accidentally dropped, guard may be bent. Check to make sure that guard moves freely and does not touch the blade or any other part, in all angles and depths of cut.
19. **Check the operation and condition of the guard return spring. If the guard and the spring are not operating properly, they must be serviced before use.** Guard may operate sluggishly due to damaged parts, gummy deposits, or a build-up of debris.
20. **Assure that the base plate of the saw will not shift while performing the “plunge cut” when the blade bevel setting is not at 90 °.** Blade shifting sideways will cause binding and likely kick back.
21. **Always observe that the guard is covering the blade before placing saw down on bench or floor.** An unprotected, coasting blade will cause the saw to walk backwards, cutting whatever is in its path. Be aware of the time it takes for the blade to stop after switch is released.

**Additional safety warnings**

22. **Use extra caution when cutting damp wood, pressure treated lumber, or wood containing knots.** Maintain smooth advancement of tool without decrease in blade speed to avoid overheating the blade tips.
23. **Do not attempt to remove cut material when blade is moving. Wait until blade stops before grasping cut material.** Blades coast after turn off.
24. **Avoid cutting nails. Inspect for and remove all nails from lumber before cutting.**

25. **Place the wider portion of the saw base on that part of the workpiece which is solidly supported, not on the section that will fall off when the cut is made. As examples, Fig. 1 illustrates the RIGHT way to cut off the end of a board, and Fig. 2 illustrates the WRONG way. If the workpiece is short or small, clamp it down. DO NOT TRY TO HOLD SHORT PIECES BY HAND!**

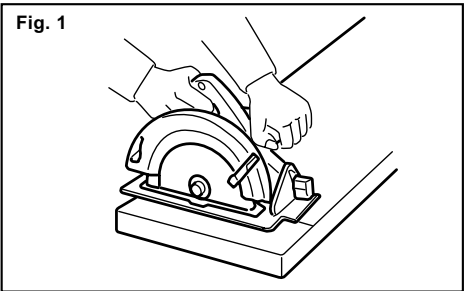

000147

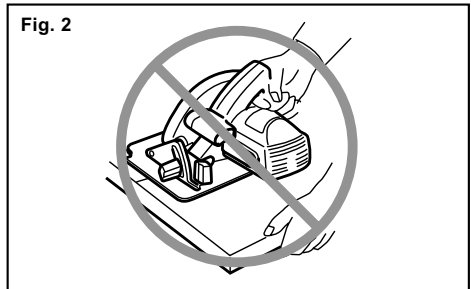

000150

26. **Before setting the tool down after completing a cut, be sure that the lower guard has closed and the blade has come to a complete stop.**
27. **Never attempt to saw with the circular saw held upside down in a vise. This is extremely dangerous and can lead to serious accidents.**

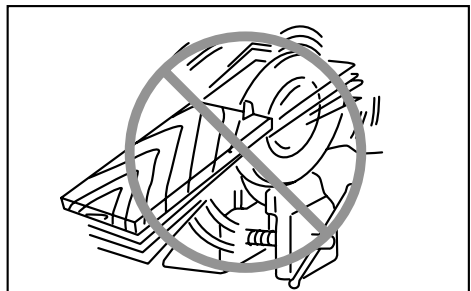

000029

28. **Some material contains chemicals which may be toxic. Take caution to prevent dust inhalation and skin contact. Follow material supplier safety data.**
29. **Do not stop the blades by lateral pressure on the saw blade.**
30. **Always use blades recommended in this manual. Do not use any abrasive wheels.**
31. **Keep blade sharp and clean.** Gum and wood pitch hardened on blades slows saw and increases potential for kickback. Keep blade clean by first removing it from tool, then cleaning it with gum and pitch remover, hot water or kerosene. Never use gasoline.
32. **Wear a dust mask and hearing protection when use the tool.**

## SAVE THESE INSTRUCTIONS.

### **⚠WARNING:**

**DO NOT let comfort or familiarity with product (gained from repeated use) replace strict adherence to safety rules for the subject product. MISUSE or failure to follow the safety rules stated in this instruction manual may cause serious personal injury.**

## FUNCTIONAL DESCRIPTION

### **⚠CAUTION:**

- Always be sure that the tool is switched off and unplugged before adjusting or checking function on the tool.

### Adjusting depth of cut

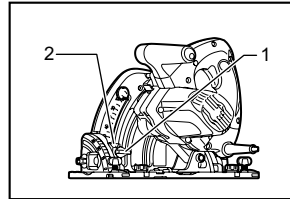

1. Clamping screw
2. Blade lower limit stopper

007656

### **⚠CAUTION:**

- After adjusting the depth of cut, always tighten the clamping screw securely.

Loosen the clamping screw on the depth guide and move the blade lower limit stopper to the desired depth on the scale plate. At the desired depth of cut, tighten the clamping screw firmly. For cleaner, safer cuts, set cut depth so that no more than one blade tooth projects below workpiece. Using proper cut depth helps to reduce potential for dangerous KICKBACKS which can cause personal injury.

### **NOTE:**

- Setting the blade lower limit stopper to the desired depth on the scale plate allows rough depth of cut. For accurate depth of cut, measure the actual protrusion of saw blade below the tool base.

### **Quick stop button for 2 to 3 mm depth of cut when using guide rail (accessory)**

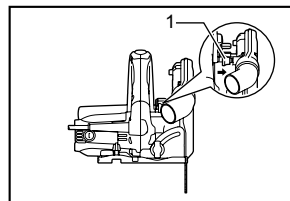

1. Quick stop button

007669

This tool has the quick stop button for 2 to 3 mm depth of cut on the gear housing aside the rear handle when using guide rail. This is used when avoiding splinter on the workpiece in the cut. Make a pass of the 2 to 3 mm first cut and then make another pass of usual cut. To obtain the 2 to 3 mm depth of cut, push in the stop button toward the saw blade. This is convenient for avoiding splinter on the workpiece.

To release the depth of cut from this position for free depth of cut, just pull the button back.

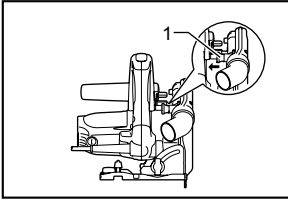

007670

1. Quick stop button

### Bevel cutting

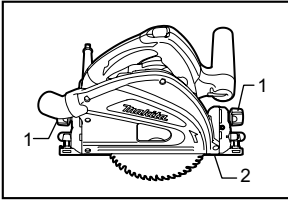

007657

1. Clamping screws
2. Tool base

### Tilting to the right

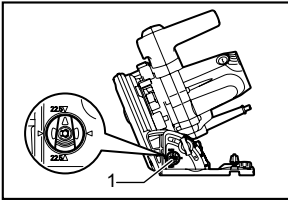

007659

1. Positive stopper

Turn the positive stopper so that the arrow on it points one of two positions (vertical for 22.5°, horizontal for 45°). Loosen the clamping screws in front and back. Then, tilt the tool base until it stops and secure the base with the clamping screws.

To get 48° bevel angle, move the lever to 48° marking as far as it will go. Turn the positive stopper so that the arrow on it points to the horizontal position. Then, tilt the tool base until it stops and secure the base with the clamping screws.

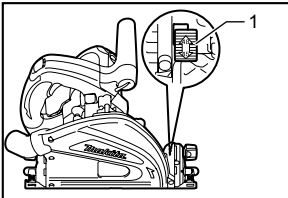

007660

1. Lever

### Tilting to the left

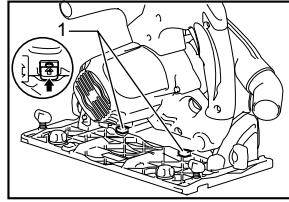

007661

1. Bevel angle shifting lever

The tool can be tilted to the left 1° bevel angle. To get the left 1° bevel angle, loosen the clamping screws in front and back, tilt the tool handle slightly to the right and push two bevel angle shifting levers at the same time in the direction of arrow which has a marking -1. And then tilt the tool handle to the left while pushing these two levers at the same time. Secure the base with the clamping screws.

### NOTE:

- Returning the blade to the right angle makes the shifting lever return to 0° by itself.

### Sighting

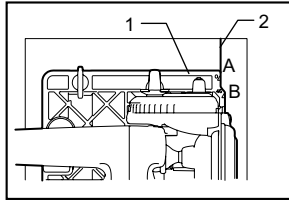

007671

1. Base
2. Cutting line

### When using the tool without guide rail (accessory)

For straight cuts, align the A position on the front of the base with your cutting line. For 45° bevel cuts, align the B position with it.

### When using the tool with guide rail (accessory)

For both straight cuts and 45° bevel cuts, always align the A position on the front of the base with your cutting line.

### Switch action

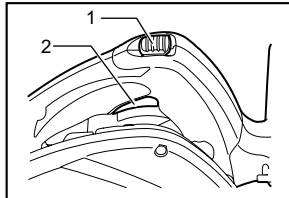

007664

1. Lock-off button
2. Switch trigger



### **⚠CAUTION:**

- Before plugging in the tool, always check to see that the switch trigger actuates properly and returns to the "OFF" position when released.

To prevent the switch trigger from being accidentally pulled, a lock-off button is provided. To start the tool, push in the lock-off button and pull the switch trigger. Release the switch trigger to stop.

### **Speed adjusting dial**

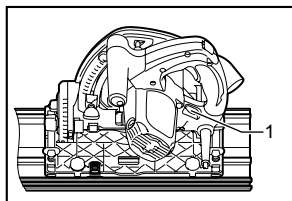

007663

1. Speed adjusting dial

The tool speed can be adjusted by turning the adjusting dial. Higher speed is obtained when the dial is turned in the direction of number 6; lower speed is obtained when it is turned in the direction of number 1.

Refer to the table to select the proper speed for the workpiece to be cut. However, the appropriate speed may differ with the type or thickness of the workpiece. In general, higher speeds will allow you to cut workpieces faster but the service life of the blade will be reduced.

Number	min <sup>-1</sup>
1	2,000
2	2,500
3	3,500
4	4,500
5	5,500
6	5,800

014599

### **⚠CAUTION:**

- The speed adjusting dial can be turned only as far as 6 and back to 1. Do not force it past 6 or 1, or the speed adjusting function may no longer work.
- The speed adjusting dial is not for using low speed rated saw blades but for obtaining a speed which is suitable to material of workpiece. Use only saw blades which are rated for at least the maximum no load speed stated in the SPECIFICATIONS.

The tools equipped with electronic function are easy to operate because of the following features.

### **Overload protector**

When the tool is overloaded and current flows above a certain level, the tool automatically stops to protect motor.

### **Constant speed control**

Electronic speed control for obtaining constant speed. Possible to get fine finish, because the rotating speed is kept constant even under load condition.

### **Soft start feature**

Soft start because of suppressed starting shock.

## **ASSEMBLY**

### **⚠CAUTION:**

- Always be sure that the tool is switched off and unplugged before carrying out any work on the tool.

### **Hex wrench storage**

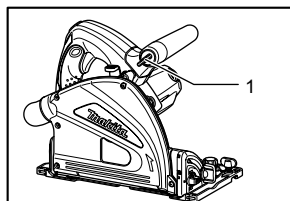

007684

1. Hex wrench

Hex wrench is stored on the tool. To remove hex wrench, just pull it out.

To install hex wrench, place it on the grip and insert it as far as it will go.

### **Removing or installing saw blade**

### **⚠CAUTION:**

- Do not use saw blades which do not comply with the characteristics specified in these instructions.
- Use only saw blades which are rated for at least the maximum no load speed stated in the SPECIFICATIONS.
- Be sure the blade is installed with teeth pointing up at the front of the tool.
- Use only the Makita wrench to install or remove the blade.

To remove the blade, push in the lock-off button to unlock the upper limit stopper.

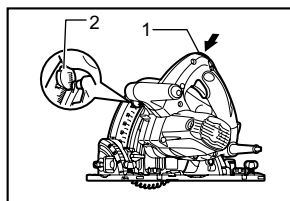

007662

1. Lock-off button
2. Locking lever

Turn the locking lever to lock the saw head for replacing a blade.

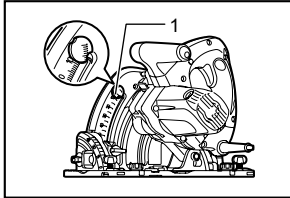

1. Locking lever

007655

With the lock-off button depressed and the locking lever turned, lower the handle so that the lock pin fits in the groove formed by the locking lever and the depth guide with scale plate. Make sure that the lock pin fits in the groove.

Press the shaft lock fully so that the blade cannot revolve and use the wrench to loosen the hex bolt counterclockwise. Then remove the hex bolt, outer flange and blade.

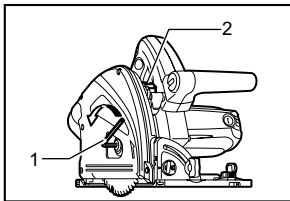

1. Hex wrench  
2. Shaft lock

007658

To install the blade, follow the removal procedure in reverse. **BE SURE TO TIGHTEN THE HEX BOLT CLOCKWISE SECURELY.**

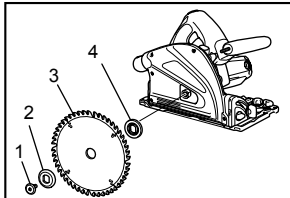

1. Hex bolt  
2. Outer flange  
3. Saw blade  
4. Inner flange

007672

### Connecting a vacuum cleaner

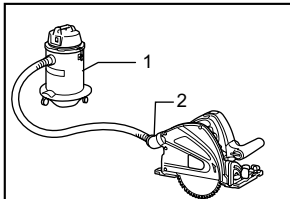

1. Vacuum cleaner  
2. Dust port

007673

When you wish to perform clean cutting operation, connect a Makita vacuum cleaner to your tool. Connect a hose of the vacuum cleaner to the dust port as shown in the figure.

## OPERATION

### Section cutting (ordinary sawing)

#### ⚠ CAUTION:

- Be sure to move the tool forward in a straight line gently. Forcing or twisting the tool will result in overheating the motor and dangerous kickback, possibly causing severe injury.
- Never approach any part of your body under the tool base when section cutting, especially at starting. Doing so may cause serious personal injuries. The blade is exposed under the tool base.

Hold the tool firmly. The tool is provided with both a front grip and rear handle. Use both to best grasp the tool. If both hands are holding saw, they cannot be cut by the blade. Set the front of base on the workpiece to be cut without the blade making any contact. Then push in the lock-off button and turn the tool on and wait until the blade attains full speed. Now press down the saw head slowly to the preset depth of cut and simply move the tool forward over the workpiece surface, keeping it flat and advancing smoothly until the sawing is completed.

To get clean cuts, keep your sawing line straight and your speed of advance uniform. If the cut fails to properly follow your intended cut line, do not attempt to turn or force the tool back to the cut line. Doing so may bind the blade and lead to dangerous kickback and possible serious injury. Release switch, wait for blade to stop and then withdraw tool. Realign tool on new cut line, and start cut again. Attempt to avoid positioning which exposes operator to chips and wood dust being ejected from saw. Use eye protection to help avoid injury.

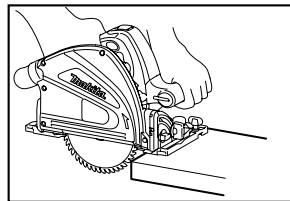

007674

## When using with guide rail (accessory)

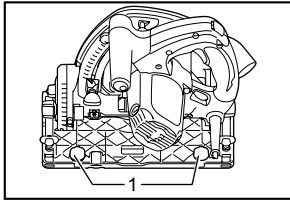

1. Adjusting screws

007685

Place the tool on the rear end of guide rail. Turn two adjusting screws on the tool base so that the tool slides smoothly without a clatter. Hold the tool firmly. The tool is provided with both a front grip and rear handle. Use both to best grasp the tool. Turn on the tool, press down the tool to the preset depth of cut and cut the splinterguard along the full length with a stroke. The edge of the splinterguard corresponds to the cutting edge. When bevel cutting with the guide rail, slide the slide lever on the tool base so that the tool does not fall down on its side.

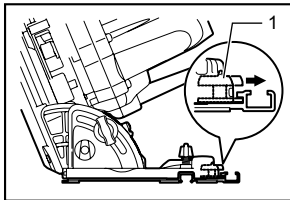

1. Slide lever

007666

Move the slide lever on the tool base in the direction of arrow so that it engages the undercut groove in the guide rail.

## Rip fence (guide rule) (Accessory)

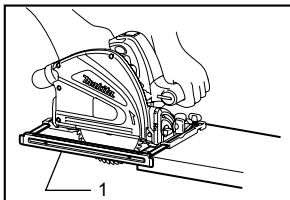

1. Rip fence  
(Guide rule)

007675

The handy rip fence allows you to do extra-accurate straight cuts. Simply slide the rip fence up snugly against the side of the workpiece and secure it in position with the screws on the front and the back of the base. It also makes repeated cuts of uniform width possible. Overturning the rip fence (guide rule) also works as a sub base for the tool.

## Plunge cutting (Cutting-out)

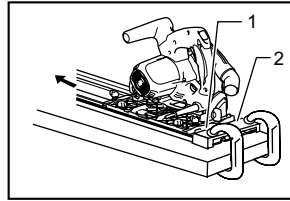

1. Rear edge of tool base  
2. Fixed stop

007686

### ⚠WARNING:

- To avoid a kickback, be sure to observe the following instructions.

### When using the tool without guide rail

Place the tool on the workpiece with the rear edge of tool base against a fixed stop or equivalent which is devised by an operator.

### When using the tool with guide rail

Place the tool on the guide rail with the rear edge of tool base against a fixed stop or equivalent which is clamped on the guide rail.

Hold the tool firmly with one hand on the front grip and the other on the tool handle. Then push in the lock-off button and turn the tool on and wait until the blade attains full speed. Now press down the saw head slowly to the preset depth of cut and simply move the tool forward to the desired plunge position.

### NOTE:

- The markings on the side of the blade guard show the absolute front and the absolute rear cutting points of the saw blade (A for diameter 160 mm and B for diameter 165 mm) at the maximum cutting depth and using the guide rail.

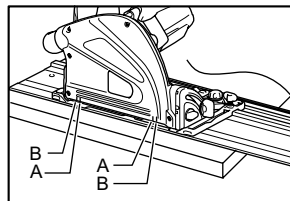

007678

## Guide device (accessories)

Use of the miter gauge (accessory) allows exact miter cuts with angles and fitting works.

Use of the clamp (accessory) ensures firm hold of workpiece on the table.

## MAINTENANCE

### ⚠ CAUTION:

- Always be sure that the tool is switched off and unplugged before attempting to perform inspection or maintenance.
- Never use gasoline, benzine, thinner, alcohol or the like. Discoloration, deformation or cracks may result.

### Adjusting for accuracy of 90° and 45° cut (vertical and 45° cut)

This adjustment has been made at the factory. But if it is off, adjust the adjusting screws with a hex wrench while inspecting 90° or 45° the blade with the base using a triangular rule or square rule, etc.

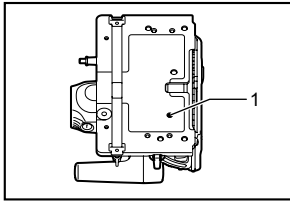

007667

1. Adjusting screw for 90°

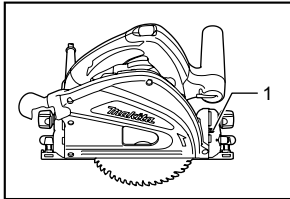

007668

1. Adjusting screw for 45°

### NOTE:

- Adjusting for accuracy of 22.5°, 48° and -1° cut cannot be performed.

### Replacing carbon brushes

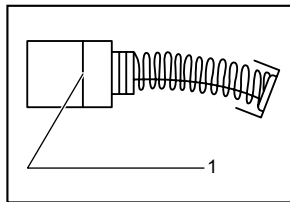

001145

1. Limit mark

Remove and check the carbon brushes regularly. Replace when they wear down to the limit mark. Keep the carbon brushes clean and free to slip in the holders. Both carbon brushes should be replaced at the same time. Use only identical carbon brushes.

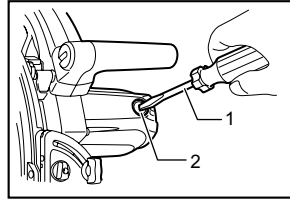

007676

1. Screwdriver  
2. Brush holder cap

Use a screwdriver to remove the brush holder caps. Take out the worn carbon brushes, insert the new ones and secure the brush holder caps.

To maintain product SAFETY and RELIABILITY, repairs, any other maintenance or adjustment should be performed by Makita Authorized Service Centers, always using Makita replacement parts.

## OPTIONAL ACCESSORIES

### ⚠ CAUTION:

- These accessories or attachments are recommended for use with your Makita tool specified in this manual. The use of any other accessories or attachments might present a risk of injury to persons. Only use accessory or attachment for its stated purpose.

If you need any assistance for more details regarding these accessories, ask your local Makita Service Center.

- Saw blades
- Guide rail
- Rip fence (Guide rule)
- Miter gauge
- Clamp
- Hex wrench
- Sheet set for guide rail
- Rubber sheet set for guide rail
- Position sheet set for guide rail

### NOTE:

- Some items in the list may be included in the tool package as standard accessories. They may differ from country to country.



---

---

---

---

---

---

---

---

---

---

---

---

---

---

---

---

---

---

---

---

---

---

---



**Makita** Jan-Baptist Vinkstraat 2, 3070, Belgium  
**Makita Corporation** Anjo, Aichi, Japan